

Dimensions of available space – 4S0

Please send by mail to info@farger-joosten.de or by fax (+49)7572-764230

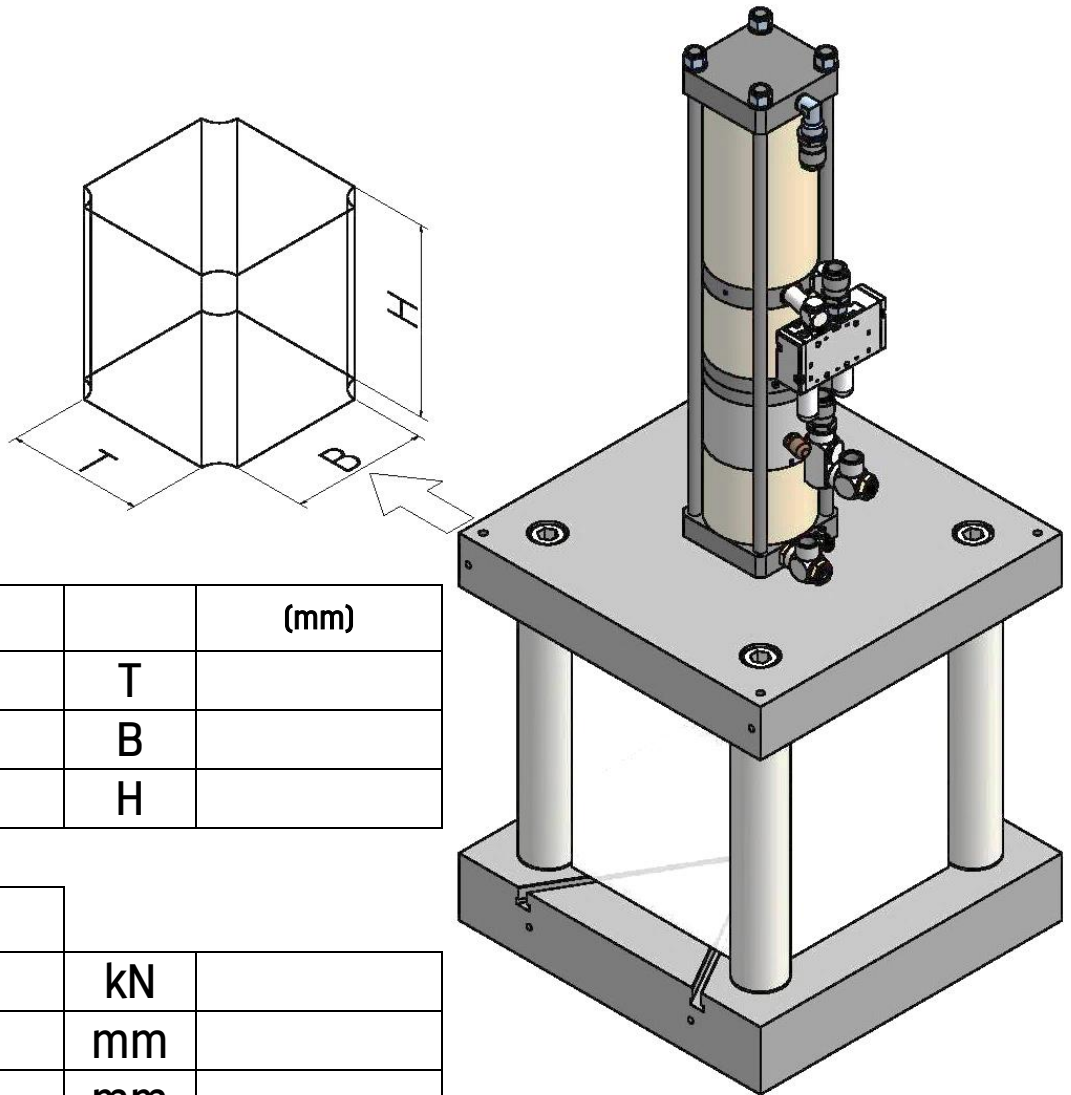

Dimensions of space		(mm)
Depth	T	
Width of plate	B	
Height	H	

Parameters of cylinder		
Requested force	kN	
Total stroke	mm	
Power stroke	mm	
Air pressure	bar	

Company data	
Company name	
Street	
Postcode / city	
Contact	
Tel.	
eMail	